

# VolvoTech.EU MANUAL

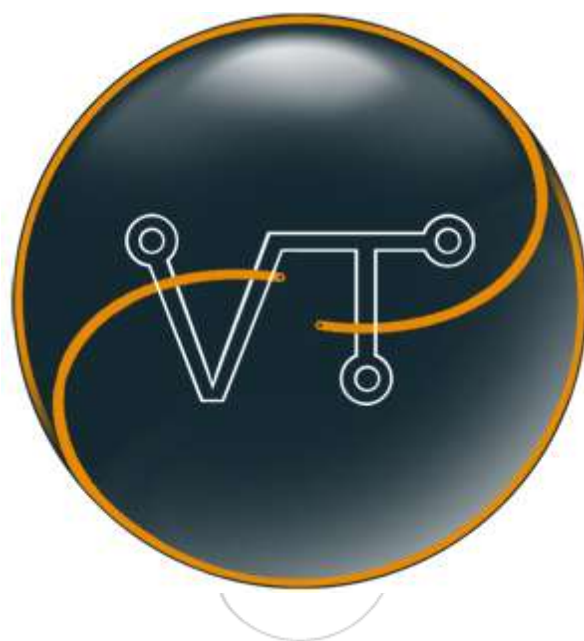

<b>Kind</b>	Connection manual
<b>Title</b>	manual-EN-connection-MMMi-parrot-bury.v1.1
<b>Language</b>	English
<b>Version</b>	1.1 Final
<b>Date</b>	November 28 <sup>th</sup> 2013
<b>Applicable to</b>	C30/S40/V50/C70/S80/V70/XC70/XC60/V60
<b>Contents</b>	Manual describes connection setup for MMMi/Parrot



# CONNECTION MANUAL

## Applicable to:

*Any installation with the MMMi, in any Volvo suitable for MMMi, either with base, highperformance or premium (Dyn) audio and connection with Parrot MKi9xxx or Bury 9XXX. (please ask in advance for suitable kits!)*

*The audio/media devices in your Volvo are connected with a MOST ring. This MOST ring is literally a ring containing devices and a glass fiber wire.*

**MOST outer-connector.** (can be only fiber or fiber with a power connection next to it, ALSO, in some cases this is the inner-and-outer-connector (see below for inner connector))



## **MOST cable and end-point connector**



**MOST inner-connector** (Usually is INSIDE the outer connector. But note; some cases there is only the outer connector with the MOST cable-end-point directly in there!)



The **orange Arrow** shows a MOST fiber connection. Showing (Arrow) the direction of the light in the MOST cable.



**Power and Parrot/Bury setup:**

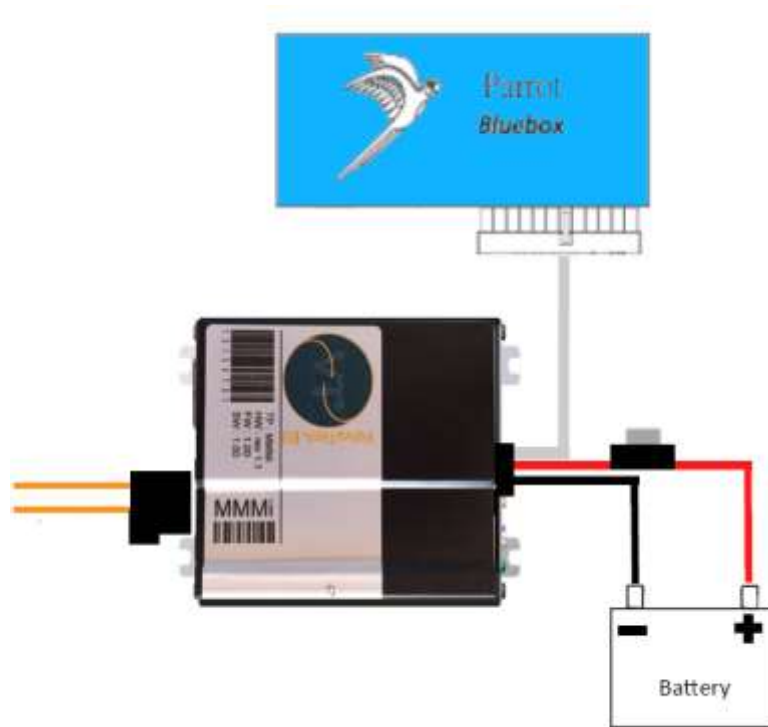

**Original setup (before MMI connection):**

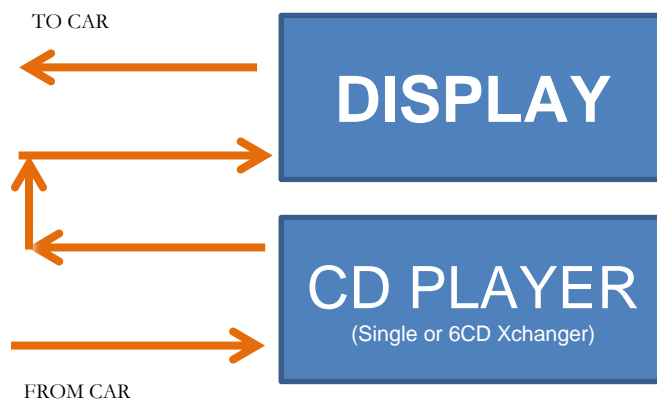



## After connection of MMMi

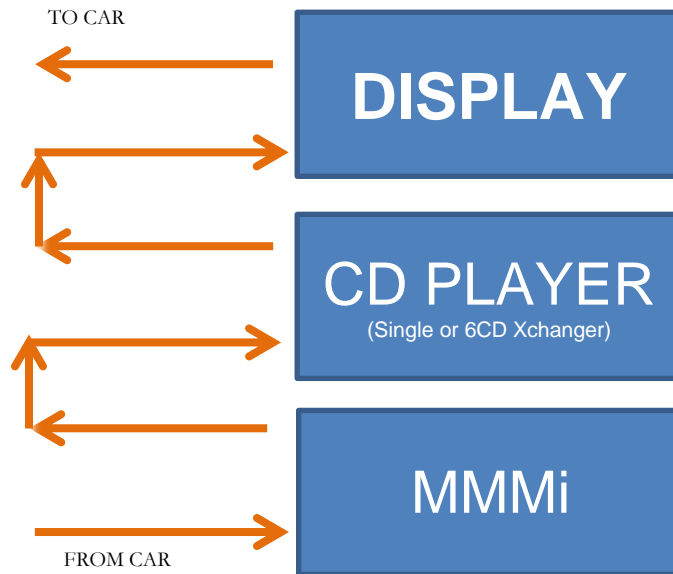

To create this connection, you need to disconnect the incoming MOST cable from the connector at the CD player.

Put the supplied MOST cable in there and the other end in the MOST connector supplied.

Then put original MOST cable (coming from car) into the supplied connector as well.



**To remove MOST cables from there connector;** perform following:

Push out the BLUE blocker from the connector.

Then lift the blocker from the connector and slightly pull the MOST cable out.

This should go VERY easy, if NOT, you have not lifted the black block enough!

Do NOT force.

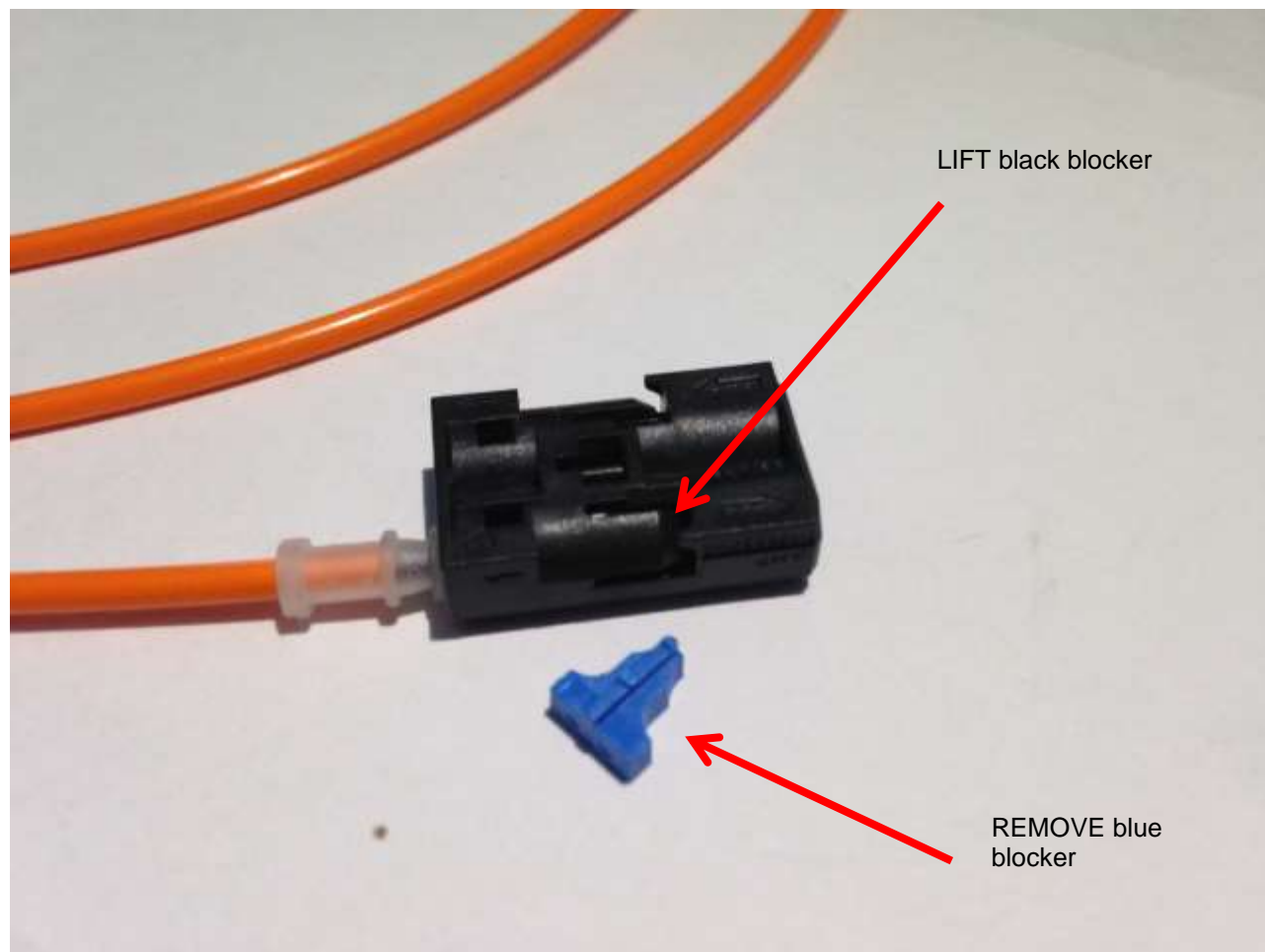



**To know what light direction is used** and you need to follow in the MOST connectors:

Look at the arrows on the inner connector (or if no inner connector is available, it is printed on the outer connector!).

IF you mixup the direction of the light, the Radio will go on for a few seconds and directly go off again!

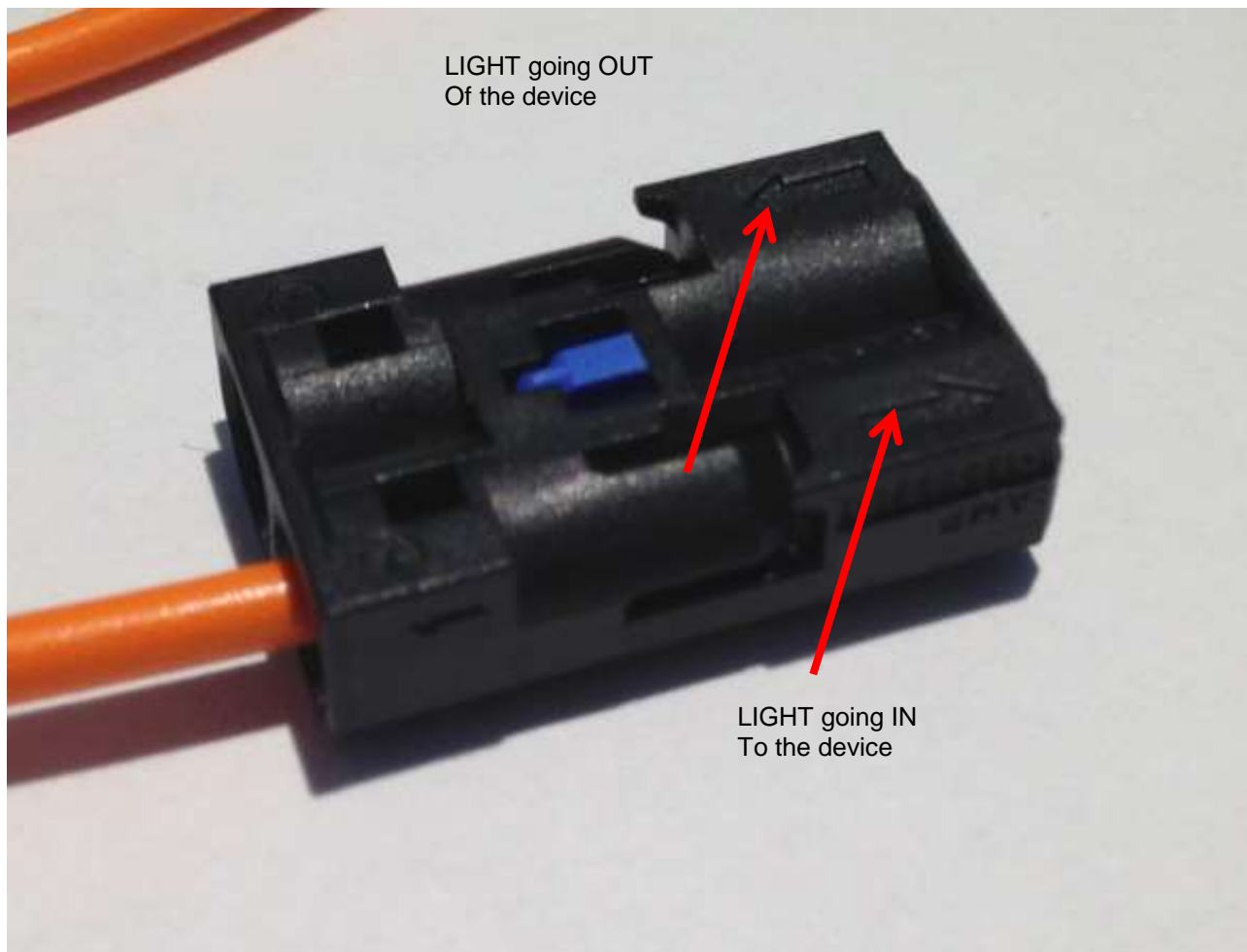



### LED information on the MMMi:

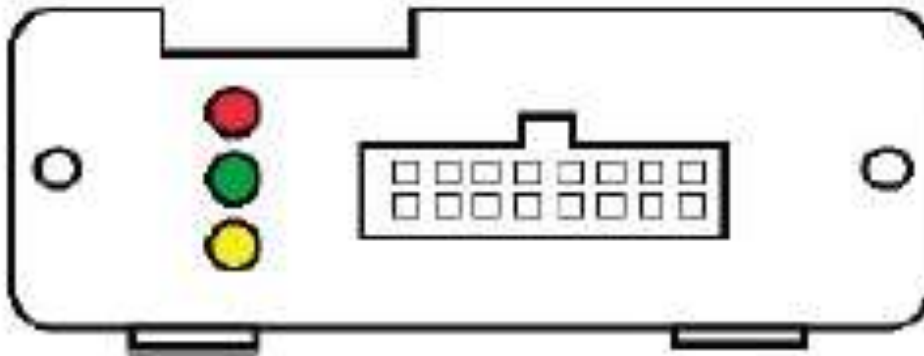

Green led	ON	MMMi = ON
Orange led	ON	MMMi = MOST network is activated OK
Red led	ON	MMMi = activated by Parrot or Aux switch
Red led	FLASH	MMMi = not recognizing your Volvo



### General need to knows:

MOST fiber cables are sensitive. Do NOT force them / break them, they will disfunction after any damage being done to them!

MOST cables being bent too much will give a bad audio result or in worst case give no audio at all!

MOST cables can NOT be stripped / soldered or so, broken is broken and requires replacement.

IF audio fails from radio or CD at testing the set, probably somewhere a mixup in light-direction has taken place. You can check by putting the ignition of the car to position 2, removing a connector and checking if the light direction is as it should be according to the connectors.

Direct compatibility is available for : Parrot 9000,9100 and 9200 and Bury 9048 and 9058.

(NOTE : Other Parrot and Bury car kits will work, but will require you to change the harness/cabling!!)

If you selected the Aux connection set, you can just switch with the supplied switch and the MMMi activates the RCA connectors audio-in.